

Data Sheet



Article number: 2307083791

Description: E+G Direct drive position indikator
DD52R-FR-0010.0-D-C3 (Grey)

Measures

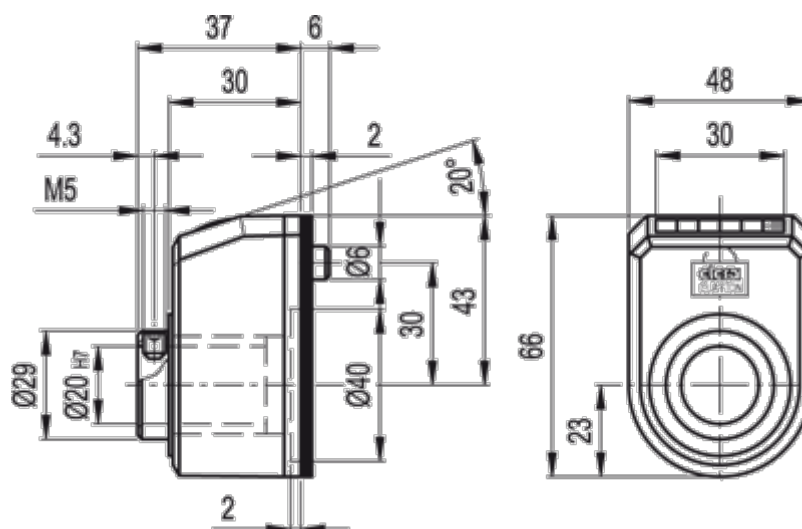

Max rpm = 250